



# Lenovo B560

User Guide v1.0



Read the safety notices and important tips in the included manuals before using your computer.

## Notes

- Before using the product, be sure to read *Lenovo Safety and General Information Guide* first.
- Some instructions in this guide may assume that you are using Windows® 7. If you are using other Windows operating system, some operations may be slightly different. If you are using other operating systems, some operations may not apply to you.
- The features described in this guide are common to most models. Some features may not be available on your computer and/or your computer may include features that are not described in this user guide.

## Regulatory Notice

- The *Regulatory Notice* provides information about the radiofrequency and safety standards. Be sure to read it before using wireless devices on your computer.
- To refer to it, go to <http://www.lenovo.com>, click **Support**, and then click **User's guides and manuals**.

First Edition (May 2010)

© Copyright Lenovo 2010.

LENOVO products, data, computer software, and services have been developed exclusively at private expense and are sold to governmental entities as commercial items as defined by 48 C.F.R. 2.101 with limited and restricted rights to use, reproduction and disclosure. LIMITED AND RESTRICTED RIGHTS NOTICE: If products, data, computer software, or services are delivered pursuant a General Services Administration "GSA" contract, use, reproduction, or disclosure is subject to restrictions set forth in Contract No. GS-35F-05925.

# Contents

<b>Chapter 1. Getting to know your computer</b> .....	<b>1</b>
Top view .....	1
Left-side view .....	3
Right-side view .....	4
Front view .....	5
Bottom view .....	6
<b>Chapter 2. Learning the basics</b> .....	<b>8</b>
First use .....	8
Using AC adapter and battery .....	10
Using the touchpad .....	11
Using the keyboard .....	12
Connecting external devices .....	14
Special keys and buttons .....	16
System status indicators .....	17
Securing your computer .....	18
<b>Chapter 3. Connecting to the Internet</b> .....	<b>19</b>
Wired connection .....	19
Wireless connection .....	20
<b>Chapter 4. OneKey Rescue system</b> .....	<b>24</b>
OneKey Rescue system .....	24
<b>Chapter 5. Troubleshooting</b> .....	<b>25</b>
Frequently asked questions .....	25
Troubleshooting .....	27
<b>Appendix A. CRU instructions</b> .....	<b>31</b>
Replacing the battery .....	31
Replacing the hard disk drive .....	32
Replacing memory .....	36
Removing the optical drive .....	39
<b>Appendix B. Lenovo limited warranty</b> .....	<b>40</b>
Warranty information .....	44
<b>Appendix C. Product specific Notices</b> .....	<b>47</b>
Energy star information .....	47
Electronic emissions notices .....	49
<b>Appendix D. Specifications</b> .....	<b>52</b>
<b>Trademarks</b> .....	<b>53</b>
<b>Index</b> .....	<b>54</b>



# Chapter 1. Getting to know your computer

## ■ ■ Top view

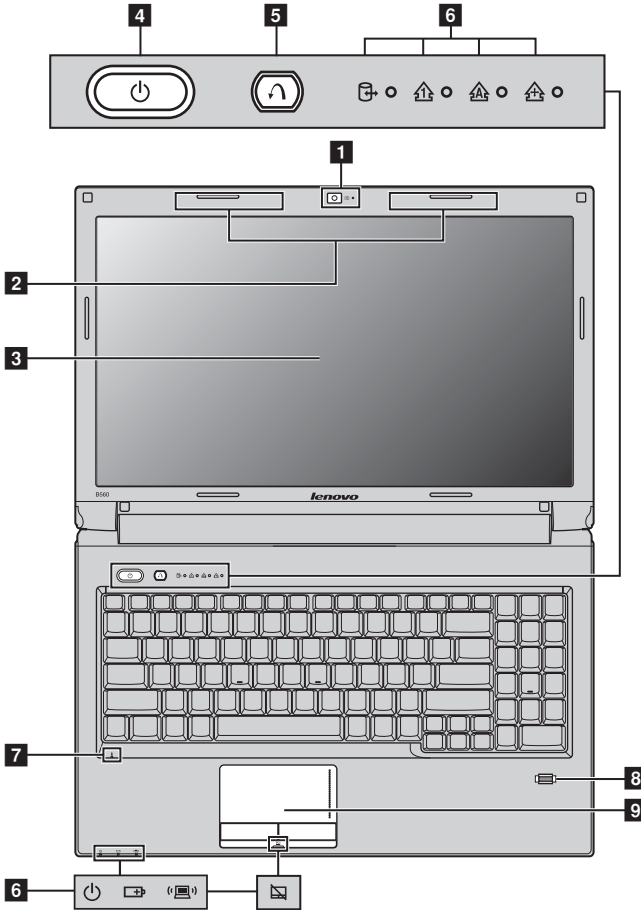

**Note:** The illustrations in this manual may differ from the actual product. Please refer to the actual product.

### ⓘ Attention:

- Do NOT open the display panel beyond 130 degrees. When closing the display panel, be careful NOT to leave pens or any other objects in between the display panel and the keyboard. Otherwise, the display panel may be damaged.

## Chapter 1. Getting to know your computer

- 1 Integrated camera (Select models only)** Use the camera for video communication.
- 2 Wireless module antennas (Select models only)** The built-in antennas ensure optimal reception of wireless radio.
- 3 Computer display** The LCD display provides brilliant visual output.
- 4 Power button** Press this button to turn on the computer.
- 5 OneKey Rescue system button** Press this button to open OneKey Rescue system (If OneKey Rescue system has been preinstalled) when the computer is powered off.

**Note:** For details, see “OneKey Rescue system” on page 24.

- 6 System status indicators** For details, see “System status indicators” on page 17.
- 7 Built-in microphone** The built-in microphone (with noise reduction) can be used for video conferencing, voice narration, or simple audio recordings.
- 8 Fingerprint reader (Select models only)** With the fingerprint reader you can register fingerprints and use them as passwords to secure your computer.
- 9 Touchpad** The touchpad functions as a conventional mouse.

**Note:** For details, see “Using the touchpad” on page 11.

## ■ ■ Left-side view

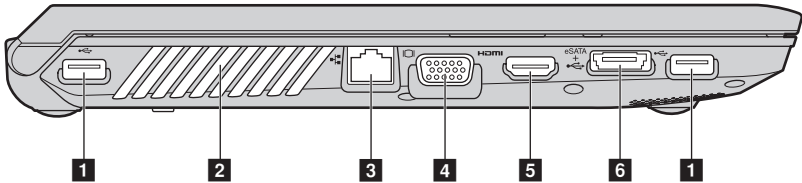

- 1 USB port** Connects to USB devices.

**Note:** For details, see “Connecting a universal serial bus (USB) device” on page 14.

- 2 Fan louvers** Dissipate internal heat.

**Note:** Make sure that none of the fan louvers are blocked or else overheating of the computer may occur.

- 3 RJ-45 port** This port connects the computer to an Ethernet network.

**Note:** For details, see “Wired connection” on page 19.

- 4 VGA port** Connects to external display devices.

- 5 HDMI port (Select models only)** Connects to devices with HDMI input such as a TV or a display.

- 6 USB port or eSATA/USB combo port (Select models only)** Connects to eSATA or USB devices.

**Note:** For details, see “Connecting a universal serial bus (USB) device” on page 14.

## ■ ■ Right-side view

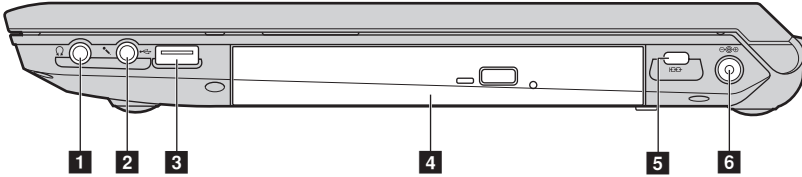

**1 Headphone jack** Connects to external headphones.

ⓘ **Attention:**

- Listening to music at high volume over extended periods of time may damage your hearing.

**2 Microphone jack** Connects to external microphones.

**3 USB port** Connects to USB devices.

**Note:** For details, see “Connecting a universal serial bus (USB) device” on page 14.

**4 Optical drive** Reads/Burns optical disks.

**5 Kensington slot** Attach a security lock (not supplied) here.

**Note:** For details, see “Attaching a security lock (not supplied)” on page 18.

**6 AC power adapter jack** Connect the AC adapter here.

**Note:** For details, see “Using AC adapter and battery” on page 10.



## ■ ■ Front view

---

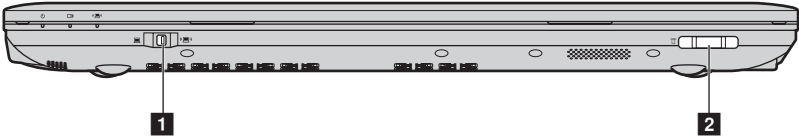

- 1 Integrated wireless device switch (Select models only)** Use this switch to turn on/off the wireless radio of all wireless devices on your computer.
- 2 Memory card slot** Insert memory cards (not supplied) here.

**Note:** For details, see “Using memory cards (not supplied)” on page 14.

■ ■ Bottom view

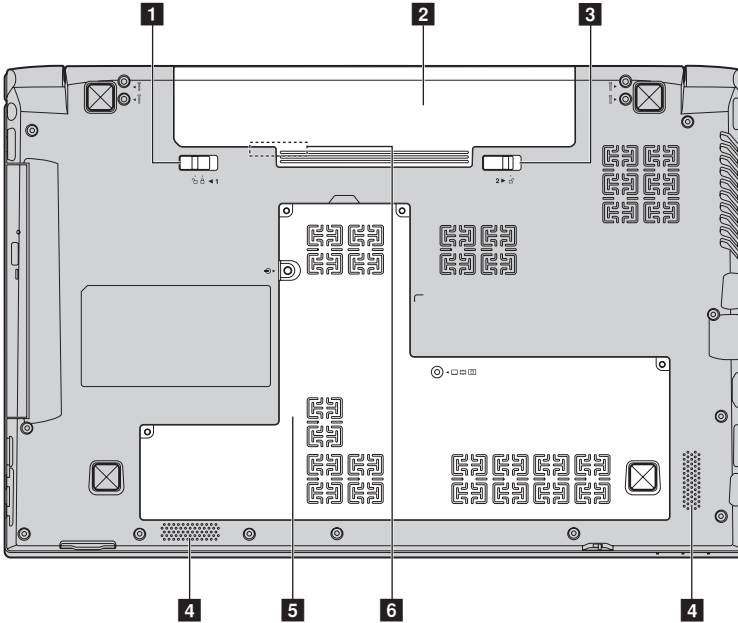

- 1 Battery latch - manual** The manual battery latch is used to keep the battery pack secured in place.
- 2 Battery pack** For details, see “Using AC adapter and battery” on page 10.
- 3 Battery latch - spring loaded** The spring-loaded battery latch keeps the battery pack secured in place.
- 4 Speakers** The stereo speakers provide rich and powerful sound.
- 5 Hard disk drive (HDD) / Memory / Mini PCI Express card slot compartment**

- 6** **SIM card slot (Select models only)** Insert a SIM card (not supplied) for using Mobile Broadband.

**Note:**

- In order to be able to insert a SIM card into this slot, you must first disconnect the AC adapter and remove the battery pack.
- For details, see “Using Mobile Broadband (Select models only)” on page 21.

## Chapter 2. Learning the basics

### ■ ■ First use

---

#### ■ Reading the manuals

Read the supplied manuals before using your computer.

#### ■ Connecting to the power

The supplied battery pack is not fully charged at purchase.

To charge the battery and begin using your computer, insert the battery pack and connect the computer to an electrical outlet. The battery is automatically charged while the computer is running on AC power.

##### **Installing the battery pack**

Refer to the supplied *Setup Poster* to install the battery pack.

##### **Connecting the computer to an electrical outlet**

- 1 Connect the power cord to the AC adapter.
- 2 Connect the AC adapter to the AC power adapter jack of the computer firmly.
- 3 Plug the power cord into an electrical outlet.

#### ■ Turning on the computer

Press the power button to turn on the computer.

#### ■ Configuring the operating system

You may need to configure the operating system when it is first used. The configuration process may include the procedures below.

- Accepting the end user license agreement
- Configuring the Internet connection
- Registering the operating system
- Creating a user account

#### ■ Putting your computer into sleep state or shutting it down

When you finish working with your computer, you can put it into sleep state or shut it down.

##### **Putting your computer into sleep state**

If you will be away from your computer for only a short time, put the computer into sleep state. When the computer is in sleep state, you can quickly wake it to resume use, and bypass the startup process.

To put the computer into sleep state, do one of the following.

- Click  and select **Sleep** from the Start menu.
- Press **Fn + F1**.

**Note:** Wait until the power indicator light starts blinking (indicating that the computer is in sleep state) before you move your computer. Moving your computer while the hard disk is spinning can damage the hard disk, causing loss of data.

To wake the computer, do one of the following.

- Press the power button.
- Press any key on the keyboard.

### ■ Shutting down your computer

If you are not going to use your computer for a day or two, shut it down.

To shut down your computer, click  and select **Shut down** from the Start menu.

### ■ ■ Using AC adapter and battery

---

#### ■ Checking battery status

You can determine the percentage of battery power remaining by checking the battery icon in the notification area.

**Note:** As each computer user has different habits and needs, it is difficult to predict how long a battery charge will last. There are two main factors:

- The amount of energy stored in the battery when you commence work.
- The way you use your computer: for example, how often you access the hard disk drive and how bright you make the computer display.

#### ■ Charging the battery

When you find that the battery power is low, you need to charge the battery or replace it with a fully charged one.

You need to charge the battery in any of the following situations:

- When you purchase a new battery
- If the battery status indicator starts blinking
- If the battery has not been used for a long time

**Notes:**

- You are advised to insert the battery pack when using your computer to prevent small particles from entering the inside of your computer.
- To increase the life of the battery pack, the computer does not start recharging the battery immediately after it drops from fully charged.
- Charge the battery at a temperature between 50 °F and 86 °F (10 °C-30 °C).
- Full charge or discharge is not required.

#### ■ Removing the battery pack

If you are not going to use the computer for an extended period of time, or if you need to send your computer to Lenovo for service, etc. remove the battery pack from the computer. Before removing the battery pack, make sure the computer has been shut down.

#### ■ Handling the battery

If the rechargeable battery pack is replaced with an incorrect type, there may be danger of an explosion. The battery pack contains a small amount of harmful substances. To avoid possible injury and detriment to the environment, pay attention to the following points:

- Replace only with a battery of the type recommended by Lenovo.
- Keep the battery pack away from fire.
- Do not expose the battery pack to water or rain.
- Do not attempt to disassemble the battery pack.
- Do not short-circuit the battery pack.
- Keep the battery pack away from children.
- Do not put the battery pack in trash that is disposed of in landfills. When disposing of the battery, comply with local ordinances or regulations and your company's safety standards.

## ■ ■ Using the touchpad

---

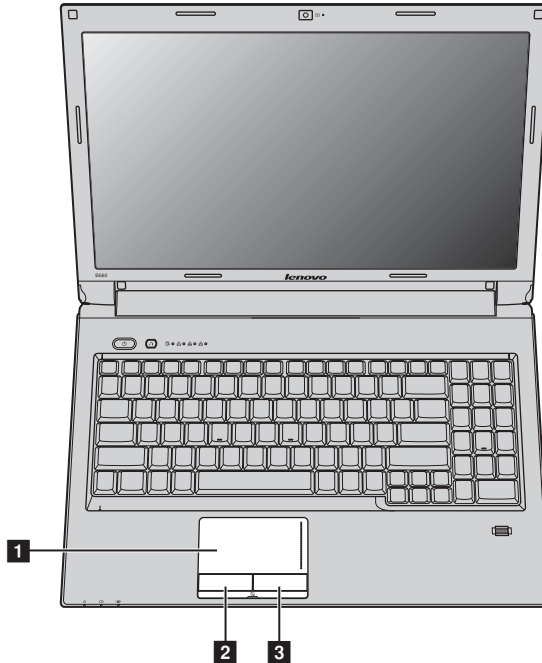

**1 Touchpad**

To move the cursor on the screen, slide your fingertip over the pad in the direction in which you want the cursor to move.

**2 Left click button**

The function corresponds to that of the left mouse button on a conventional mouse.

**3 Right click button**

The function corresponds to that of the right mouse button on a conventional mouse.

**Notes:**

- You can enable/disable the touchpad using **Fn+F8**.
- When the touchpad indicator is lit, the touchpad is disabled.

## Chapter 2. Learning the basics

### ■ ■ Using the keyboard

Your computer has a numeric keypad and function keys incorporated in its standard keyboard.

#### ■ Numeric keypad

The keyboard has a separate numeric keypad. To enable or disable the numeric keypad, press the **Num Lock** key.

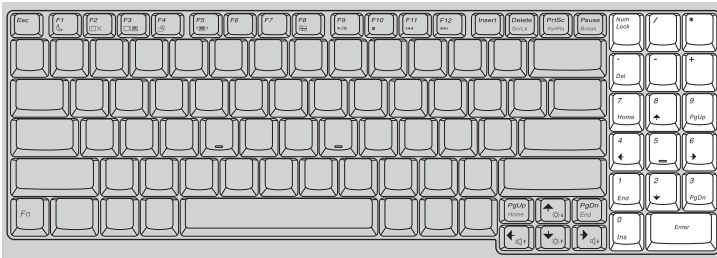

**Note:** The Num lock indicator will light on if the numeric keypad is enabled.

#### ■ Function key combinations

Through the use of the function keys, you can change operational features instantly. To use this function, press and hold **Fn** **1**; then press one of the function keys **2**.

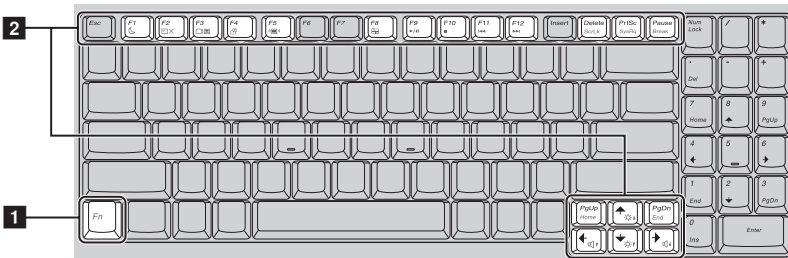



The following describes the features of each function key.

<b>Fn + F1:</b>	Enter sleep mode.
<b>Fn + F2:</b>	Turn on/off the backlight of the LCD screen.
<b>Fn + F3:</b>	Open the interface for the display device switch to select this notebook or an external display.
<b>Fn + F4:</b>	Open the interface for display resolution settings.
<b>Fn + F5:</b>	Open the interface for integrated wireless devices settings (on/off).
<b>Fn + F8:</b>	Enable/Disable the touchpad.
<b>Fn + F9:</b>	Start/Pause playback of Windows Media Player.
<b>Fn + F10:</b>	Stop playback of Windows Media Player.
<b>Fn + F11:</b>	Skip to the previous track.
<b>Fn + F12:</b>	Skip to the next track.
<b>Fn + Delete:</b>	Enable/Disable the scroll lock.
<b>Fn + PrtSc:</b>	Activate the system request.
<b>Fn + Pause:</b>	Activate the break function.
<b>Fn + ↑ / ↓:</b>	Increase/Decrease display brightness.
<b>Fn + → / ←:</b>	Increase/Decrease sound volume.

## Chapter 2. Learning the basics

### ■ ■ Connecting external devices

---

Your computer has a wide range of built-in features and connection capabilities.

#### ■ Using memory cards (not supplied)

Your computer supports the following types of memory cards:

- Secure Digital (SD) card
- MultiMediaCard (MMC)
- Memory Stick (MS)
- Secure Digital PRO (SD PRO)

**Notes:**

- Insert **ONLY** one card in the slot at a time.
- This card reader does not support SDIO devices (e.g., SDIO Bluetooth, etc.).

#### Inserting a memory card

- ➊ Push the dummy card until you hear a click. Gently pull the dummy card out of the memory card slot.

**Note:** The dummy card is used for preventing dust and small particles from entering the inside of your computer when the memory card slot is not in use. Retain the dummy card for future use.

- ➋ Slide the memory card in until it clicks into place.

#### Removing a memory card

- ➊ Push the memory card until you hear a click.
- ➋ Gently pull the memory card out of the memory card slot.

**Note:** Before removing the memory card, disable it via Windows safely remove hardware and eject media utility to avoid data corruption.

#### ■ Connecting a universal serial bus (USB) device

Your computer comes with three USB ports and an eSATA/USB port compatible with USB devices.



**Note:** When using a high power consumption USB device such as USB ODD, use the external device's power adapter. Otherwise, the device may not be recognized, and system shut down may result.

### ■ Connecting a *Bluetooth* device (Select models only)

If your computer has an integrated *Bluetooth* adapter card, it can connect to and transfer data wirelessly to other *Bluetooth* enabled devices, such as notebook computers, PDAs and cell phones. You can transfer data between these devices without cables and up to 10 meters range in open space.

**Note:** The actual maximum range may vary due to interference and transmission barriers. To get the best possible connection speed, place the device as near your computer as possible.

### Enabling *Bluetooth* communications on your computer

- 1 Slide the integrated wireless device switch from  to .
- 2 Press **Fn + F5** to make configuration.

#### **Notes:**

- When you do not need to use the *Bluetooth* function, turn it off to save battery power.
- You need to pair the *Bluetooth* enabled device with your computer before you can transfer data between them. Read the documentation supplied with the *Bluetooth* enabled device for details on how to pair the device with your computer.

## ■ ■ Special keys and buttons

---

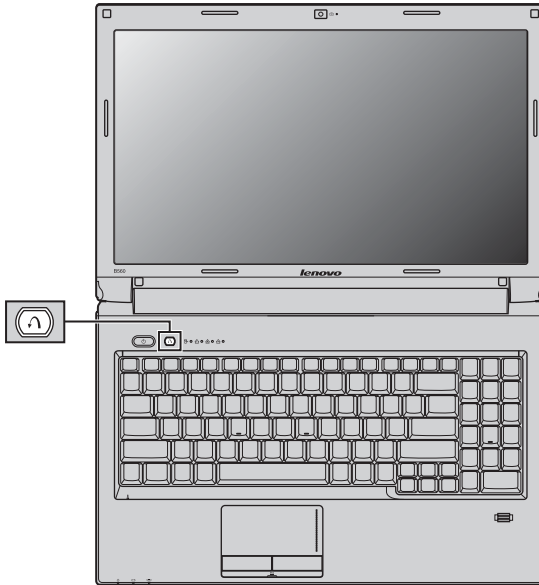

### ■ OneKey Rescue system button









- When the computer is powered-off, press this button to enter the OneKey Rescue system if Lenovo OneKey Rescue system has been preinstalled.
- In Windows operating system, press this button to start Lenovo OneKey Recovery.

**Note:** For details, see “OneKey Rescue system” on page 24.

## ■ System status indicators

These indicators inform you of the computer status.



- 1** Hard disk drive indicator 
- 2** Num lock indicator 
- 3** Caps lock indicator 
- 4** Scroll lock indicator 
- 5** Power status indicator 
- 6** Battery status indicator 
- 7** Wireless communication indicator 
- 8** Touchpad indicator 

## Chapter 2. Learning the basics

### ■ ■ Securing your computer

---

This section provides information about how to help protect your computer from theft and unauthorized use.

#### ■ Attaching a security lock (not supplied)

You can attach a security lock to your computer to help prevent it from being removed without your permission. For details on installing the security lock, please refer to the instructions shipped with the security lock that you have purchased.

Refer to the “Right-side view” on page 4 for the location of the Kensington slot.

**Notes:**

- Before purchasing any security product, verify that it is compatible with this type of security keyhole.
- You are responsible for evaluating, selecting, and implementing the locking devices and security features. Lenovo offers no comment judgement or warranty regarding the function, quality or performance of locking devices and security features.

#### ■ Using passwords

Using passwords helps prevent your computer from being used by others. Once you set a password and enable it, a prompt appears on the screen each time you power on the computer. Enter your password at the prompt. The computer cannot be used unless you enter the correct password.

**Note:** This password can be from one to seven alphanumeric characters in any combination.

For details about how to set the password, see the Help to the right of the screen in BIOS setup utility.

**Note:** To enter BIOS setup utility, press **F2** when the Lenovo logo appears on the screen while the computer is starting up.

#### ■ Fingerprint reader (Select models only)

With the fingerprint reader, in addition to registering fingerprint information and using it as a password for Windows operating system or Web site logon, you can also launch applications quickly and encrypt private data with your fingerprint to secure your computer.

For more details on fingerprint reader, see the Help file of your software.

# Chapter 3. Connecting to the Internet

As a global network, the Internet connects computers worldwide, providing services such as e-mailing, information searching, electronic commerce, Web browsing and entertainment.

You can connect the computer to the Internet in the following ways:

**Wired connection:** use physical wiring to connect.

**Wireless network technology:** connect without wiring.

## ■ ■ Wired connection

Wired connections are a reliable and safe way to connect the computer to the Internet.

Cable	Cable Internet services use a cable modem connected to the residential cable TV line.
DSL	DSL is a family of related technologies that bring high-speed network access to homes and small businesses over ordinary telephone lines.

## ■ Hardware connection

### Cable

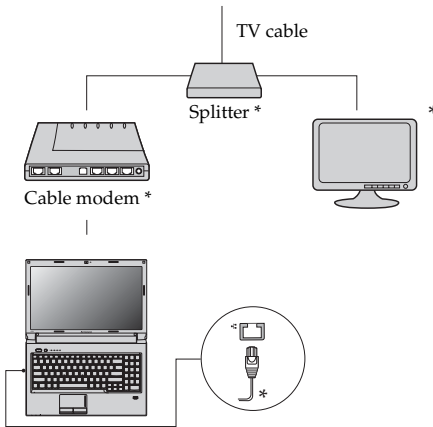

### DSL

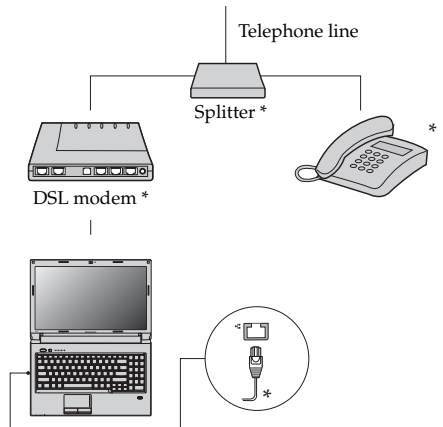

\* Not supplied.

**Note:** The above diagrams are for reference only. Actual connection method may vary.

## ■ Software configuration

Consult your Internet Service Provider (ISP) for details on how to configure your computer.

### ■ ■ Wireless connection

Wireless connections provide mobile access to the Internet, allowing you to stay online anywhere the wireless signal covers.

Divided by the signal scales, wireless connection to the Internet can be built based on the following standards.



Wi-Fi	Wi-Fi networks cover a small physical area, like a home, office, or small group of buildings. An access point is necessary for the connection.
WiMAX	WiMAX networks connect several Wireless LAN systems to cover a metropolitan area, providing high-speed broadband access without the need for cables.
Mobile Broadband	The Mobile Broadband network provides Internet access to computers, cell phones and other devices over a large geographic area. Mobile networks are used for data transmission, and access is usually provided by a mobile network operator. A Mobile Broadband SIM card is necessary for the connection.

**Note:** Your computer may not support all wireless connection methods.

### ■ Using Wi-Fi/WiMAX (Select models only)

#### Enabling wireless connection

To enable wireless communications, do the following:

- 1 Slide the integrated wireless device switch from  to .
- 2 Press **Fn + F5** to make configuration.

#### Hardware connection

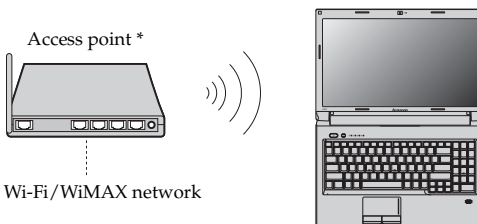

\* Not supplied

#### Software configuration

Consult your Internet Service Provider (ISP) and search Windows Help and Support Center for details on how to configure your computer.



### ■ Using Mobile Broadband (Select models only)

Before getting started with Mobile Broadband, you first need to choose a mobile network operator and make sure you are in the coverage area of the network. After that, you also need:

- To activate the Mobile Broadband service through your local mobile network operator. You will get a Subscriber Identity Module (SIM) card after activation. For instructions on inserting the SIM card, refer to “Inserting the SIM card” on page 22.

#### **Notes:**

- Various standards are in use by mobile operators to provide Mobile Broadband services. The Lenovo Mobile Broadband module may support one or more of the following standards:
  - GSM (Global System for Mobile Communications)
  - TD-SCDMA (Time Division-Synchronous Code Division Multiple Access)
  - SCDMA (Synchronous Code Division Multiple Access)
  - EV-DO (Evolution Data Optimized)
  - HSPA (High Speed Packet Access)
- Mobile Broadband is a subscription service. Refer to your local mobile network operator for availability, cost and other information.
- A SIM card is a type of smart card used by mobile network operators to identify their service subscribers on the mobile network. You will get the SIM card from your mobile network operator after you have activated the Mobile Broadband service.

- A connection management utility to connect/disconnect to your Mobile Broadband network.

**Note:** In general, your mobile service provider provides this utility.

## Chapter 3. Connecting to the Internet

### Inserting the SIM card

To insert the SIM card:

- 1 Turn off the computer; then disconnect the AC adapter and all cables from the computer.
- 2 Close the computer display and turn it over.
- 3 Remove the battery.
- 4 Insert the SIM card in the card slot until it clicks into place as shown in the illustration.

**Note:** Inserting the SIM card in the wrong direction may damage the SIM card slot.

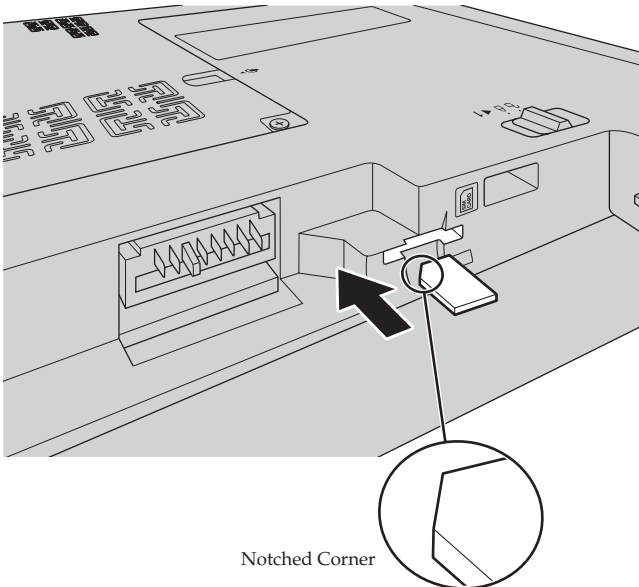

- 5 Put the battery back in place. Turn the computer over and reconnect the cables.

### Removing the SIM card

To remove the SIM card:

- 1 Turn off the computer, then disconnect the AC adapter and all cables from the computer.
- 2 Close the computer display and turn it over.
- 3 Remove the battery.
- 4 Push the SIM card in until you hear a click, and then pull the SIM card out.

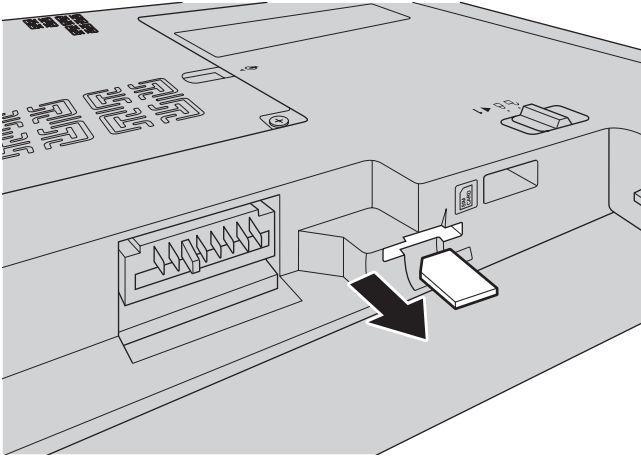

- 5 Put the battery back in place. Turn the computer over and reconnect the cables.

**Note:** Never insert or remove the SIM card while the computer is on. Doing so may cause permanent damage to the SIM card as well as the SIM card reader.

# Chapter 4. OneKey Rescue system

## ■ ■ OneKey Rescue system

---

### ■ Introduction

The Lenovo OneKey Rescue system is an easy-to-use application that can be used to back up the data on your system partition (C drive) for easy restore when required. You can run Lenovo OneKey Recovery under the Windows operating system, and the OneKey Rescue system without starting the Windows operating system.

#### © Attention:

In order to utilize the features of the OneKey Rescue system, your hard disk already includes a hidden partition by default to store the system image file and OneKey Rescue system program files. This default partition is hidden for security reasons and is the reason the available disk space is less than it claims. The exact available hard disk space depends on the file size of the mirror image file (based on the size of operating system and preinstalled software).

### ■ Using Lenovo OneKey Recovery (within Windows operating system)

In Windows operating system, double click the OneKey Recovery system Icon on the desktop to launch Lenovo OneKey Recovery.

Within the program, you can back up the system partition on the hard disk drive, other storage devices, or by creating recovery discs.

#### Notes:

- The backup process and creation of recovery discs may take some time, connect the AC adapter and battery pack to your computer.
- After the recovery discs are burned, please number them so that you can use them in the correct order.
- Computers without an integrated optical drive support the creation of recovery discs; however an appropriate external optical drive is needed to physically create the recovery discs.

**For more instructions, see the Help file of Lenovo OneKey Recovery.**

### ■ Using Lenovo OneKey Rescue system (without Windows operating system)

In the event that the operating system cannot be loaded, follow the steps below to access OneKey Rescue system.

- Shut down your computer.
- Press the  key to launch OneKey Rescue system.

Within the program, you can choose to restore your system partition to the original factory status, or to a previously generated backup.

**Note:** The recovery process is irreversible. Make sure to back up any critical data before using the recovery feature.

# Chapter 5. Troubleshooting

## ■ ■ Frequently asked questions

---

This section lists frequently asked questions and tells where you can find detailed answers. For details about each publication included in the package with your computer, see *Lenovo B560 Setup Poster*.

### **What safety precautions should I follow when using my computer?**

See "Chapter 1. Important safety information" of *Lenovo Safety and General Information Guide*.

### **How can I prevent problems with my computer?**

See "Chapter 2. Use and care Information" of *Lenovo Safety and General Information Guide*.

### **What are the main hardware features of my new computer?**

More information can be found in Chapter 1 and 2.

### **Where can I find the detailed specifications for my computer?**

See <http://consumersupport.lenovo.com>.

### **I need to upgrade a device or I need to replace one of the following: the hard disk drive, memory, or the keyboard.**

See "Appendix A. CRU instructions" on page 31 of this guide.

### **Where are the recovery discs?**

Your computer did not come with a recovery disc. For an explanation of the alternative recovery methods offered by Lenovo, see "Chapter 4. OneKey Rescue system" on page 24.

### **How can I contact the customer support center?**

See "Chapter 3. Getting help and service" of *Lenovo Safety and General Information Guide*.

### **Where can I find warranty information?**

For the warranty applicable to your computer, including the warranty period and type of warranty service, see "Appendix B. Lenovo limited warranty" on page 40.

### **How can I install the device drivers?**

A compatible device driver is a requirement to ensure correct operation and performance of each component in your computer. If your computer is pre-installed with an operating system, Lenovo provides all drivers that you need in your hard disk.

### **What can I do if the backup process fails?**

If you can start the backup feature without a problem, but it fails during the backup process, please try the following steps:

- 1 Close other applications, then restart the backup process.
- 2 Check if the destination media is damaged, try to select another path and then try again.

## Chapter 5. Troubleshooting

### When do I need to restore the system to the factory status?

You can use this feature when your system fails or you need to re-install your operating system. This will restore your computer back to the initial status when you first booted up your computer after receiving it from the store. If there is critical data on your current partition, back it up before you run this recovery feature.

## ■ ■ Troubleshooting

If you do not find your problem here, see Chapter 2. The following section only describes problems that might negate the need to refer to the more comprehensive information in Chapter 2.

### Display problems

When I turn on the computer, nothing appears on the screen.

- If the screen is blank, make sure that:
  - The battery is installed correctly.
  - The AC adapter is connected to the computer and the power cord is plugged into a working electrical outlet.
  - The computer power is on. (Press the power button again for confirmation.)
  - The memory is installed correctly.
- If these items are properly set, and the screen remains blank, have the computer serviced.

When I turn on the computer, only a white cursor appears on a blank screen.

- Restore backed-up files to your Windows environment or the entire contents of your hard disk to the original factory contents using OneKey Recovery. If you still see only the cursor on the screen, have the computer serviced.

My screen goes blank while the computer is on.

- Your screen saver or power management may be enabled. Do one of the following to exit from the screen saver or to resume from sleep or hibernation mode:
  - Touch the touchpad.
  - Press any key on the keyboard.
  - Press the power button.
  - Press **Fn+F2** to confirm whether the LCD screen has been turned off.

### A Password problem

I forgot my password.

- If you forget your user password, you must take your computer to a Lenovo authorized servicer or a marketing representative to have the password changed.
- If you forget your HDD password, a Lenovo authorized servicer cannot reset your password or recover data from the hard disk. You must take your computer to a Lenovo authorized servicer or a marketing representative to have the hard disk drive replaced. Proof of purchase is required, and a fee will be charged for parts and service.
- If you forget your supervisor password, a Lenovo authorized servicer cannot reset your password. You must take your computer to a Lenovo authorized servicer or a marketing representative to have the system board replaced. Proof of purchase is required, and a fee will be charged for parts and service.

## Chapter 5. Troubleshooting

### Sleep or hibernation problems

The critical low-battery error message appears, and the computer immediately turns off.

- The battery power is getting low. Connect the AC adapter to the computer, or replace the battery with a fully charged one.

The computer enters sleep mode immediately after Power-on self-test (POST).

- Make sure that:
  - The battery is charged.
  - The operating temperature is within the acceptable range. See “Chapter 2. Use and care Information” of Lenovo Safety and General Information Guide.

**Note:** If the battery is charged and the temperature is within range, have the computer serviced.

The computer does not return from sleep mode and the computer does not work.

- If the computer does not return from sleep mode, it may have entered hibernation mode automatically because the battery is depleted. Check the power indicator.
- If your computer is in sleep mode, connect the AC adapter to the computer, then press any key or the power button.
- If your computer is in hibernation mode or power-off state, connect the AC adapter to the computer, then press the power button to resume operation.

**Note:** If the system still does not return from sleep mode, your system has stopped responding, and you cannot turn off the computer; reset the computer. Unsaved data may be lost. To reset the computer, press and hold the power button for 4 seconds or more. If the computer is still not reset, remove the AC adapter and the battery.

### Computer screen problems

The screen is blank.

- Do the following:
  - If you are using the AC adapter, or using the battery, and the battery status indicator is on, press **Fn** + **↑** to make the screen brighter.
  - If the power indicator is in blinking, press the power button to resume from the sleep mode.
  - If the problem persists, follow the solution in the following problem “The screen is unreadable or distorted.”
  - Press **Fn+F2** to confirm whether the LCD screen has been turned off.

The screen is unreadable or distorted.

- Make sure that:
  - The display device driver is installed correctly.
  - The screen resolution and color quality are correctly set.
  - The monitor type is correct.

Incorrect characters appear on the screen.

- Did you install the operating system or application program correctly? If they are installed and configured correctly, have the computer serviced.

### Sound problems

No sound can be heard from the speaker even when the volume is turned up.

- Make sure that:
  - The Mute function is off.
  - The headphone jack is not used.
  - Speakers are selected as the playback device.



### Battery problems

Your computer shuts down before the battery status indicator shows empty.

-or-

Your computer operates after the battery status indicator shows empty.

The operating time for a fully charged battery is short.

The computer does not operate with a fully charged battery.

The battery does not charge.

- Discharge and recharge the battery.
- For details, see “Handling the battery” in Chapter 2.
- The surge protector in the battery might be active. Turn off the computer for one minute to reset the protector; then turn on the computer again.
- For details, see “Handling the battery” in Chapter 2.

### A hard disk drive problem

The hard disk drive does not work.

- In the **Boot** menu in BIOS setup utility, make sure that the hard disk drive is included in the **Boot priority order** correctly.

### A startup problem

The Microsoft® Windows operating system does not start.

- Use the OneKey Rescue system to help solve or identify your problem. For details about OneKey Rescue system, see “Chapter 4. OneKey Rescue system” on page 24.

### OneKey Rescue system problems

Backup cannot be made.

Fail to restore system partition to factory default.

- You are not currently using a Windows operating system.
- There is not enough space to store the backed up data. You will need to free more hard disk space on your system partition (C drive).
- The system partition, such as the partition size or the drive capacity of C, has been modified.

## Chapter 5. Troubleshooting

### Other problems

- Your computer does not respond.
- To turn off your computer, press and hold the power button for 4 seconds or more. If the computer still does not respond, remove the AC adapter and the battery.
  - Your computer might lock when it enters sleep mode during a communication operation. Disable the sleep timer when you are working on the network.
- The computer does not start from a device you want.
- See the **Boot** menu of the BIOS setup utility. Make sure that the **Boot priority order** in the BIOS setup utility is set so that the computer starts from the device you want.
  - Also make sure that the device from which the computer starts is enabled. In the **Boot** menu in the BIOS setup utility, make sure that the device is included in the **Boot priority order** list.
  - Press **F12** when the Lenovo logo appears on the screen while the computer is starting up to select the device you want the computer starts from.
- The connected external device does not work.
- Do not connect or disconnect any external device cables other than USB while the computer power is on; otherwise, you might damage your computer.
  - When using a high power consumption external devices such as an external USB optical disk drive, use external device power adapter. Otherwise, the device may not be recognized, or system shut down may result.

For more technical support, please visit consumer product website  
<http://consumersupport.lenovo.com>.

# Appendix A. CRU instructions

## ■ ■ Replacing the battery

**Note:** Use only the battery provided by Lenovo. Any other battery could ignite or explode.

To replace the battery, do the following:

- 1 Turn off the computer, or enter hibernation mode. Disconnect the AC adapter and all cables from the computer.
- 2 Close the computer display, and turn the computer over.
- 3 Unlock the manual battery latch **1**. Holding the spring-loaded battery latch in the unlocked position **2**, remove the battery pack in the direction shown by the arrow **3**.

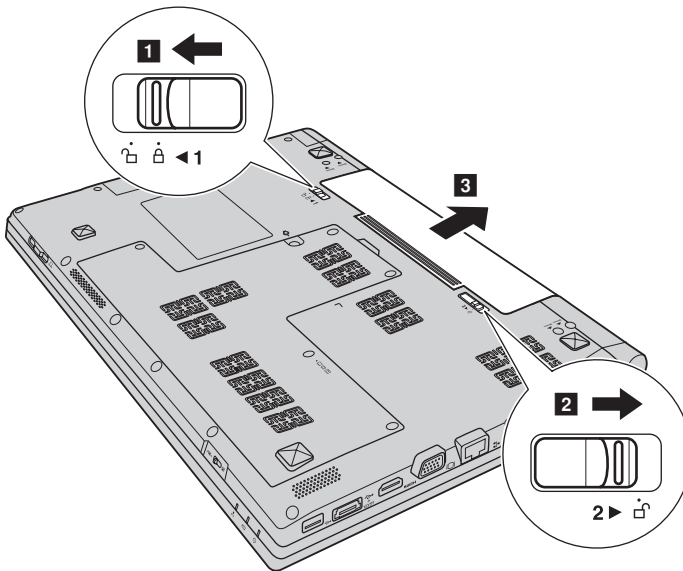

- 4 Install a fully charged battery.
- 5 Slide the manual battery latch to the locked position.
- 6 Turn the computer over again. Connect the AC adapter and the cables to the computer again.

### ■ ■ Replacing the hard disk drive

---

You can increase the storage capacity of your computer by replacing the hard disk drive with one of greater capacity. You can purchase a new hard disk drive from your reseller or Lenovo marketing representative.

**Notes:**

- Replace the hard disk drive only if you upgrade it or have it repaired. The connectors and bay of the hard disk drive were not designed for frequent changes, or drive swapping.
- The preinstalled softwares are not included on an optional hard disk drive.

**Handling a hard disk drive**

- Do not drop the drive or subject it to physical shocks. Put the drive on a material, such as soft cloth, that absorbs the physical shock.
- Do not apply pressure to the cover of the drive.
- Do not touch the connector.

The drive is very sensitive. Incorrect handling can cause damage and permanent loss of data on the hard disk. Before removing the hard disk drive, make a backup copy of all the information on the hard disk, and then turn the computer off. Never remove the drive while the system is operating, in sleep mode, or in hibernation mode.

To replace the hard disk drive, do the following:

- ❶ Turn off the computer; then disconnect the AC adapter and all cables from the computer.
- ❷ Close the computer display, and then turn the computer over.
- ❸ Remove the battery pack.
- ❹ Remove the Hard disk drive (HDD)/Memory/Mini PCI Express Card slot compartment cover.
  - a. Loosen the screws that secure the compartment cover ❶.
  - b. Remove the compartment cover ❷.

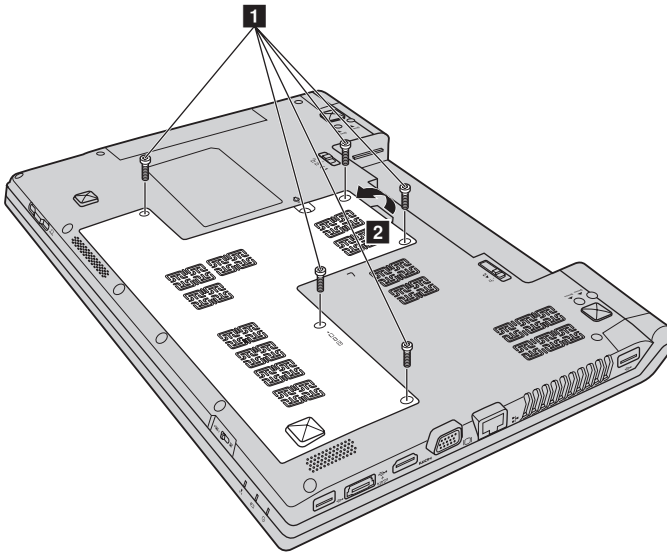

## Appendix A. CRU instructions

- 5 Remove the frame fixing screw 3.

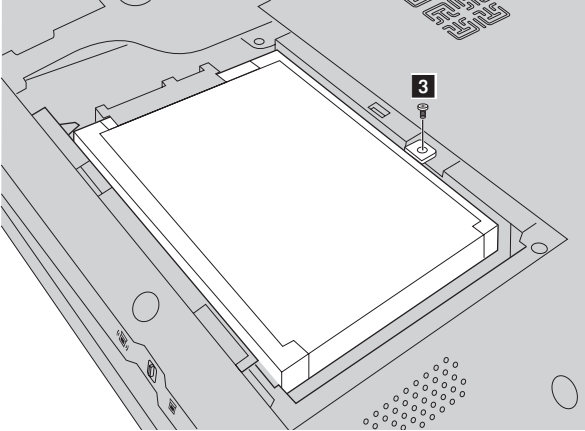

- 6 Pull the tab in the direction shown by arrow 4.

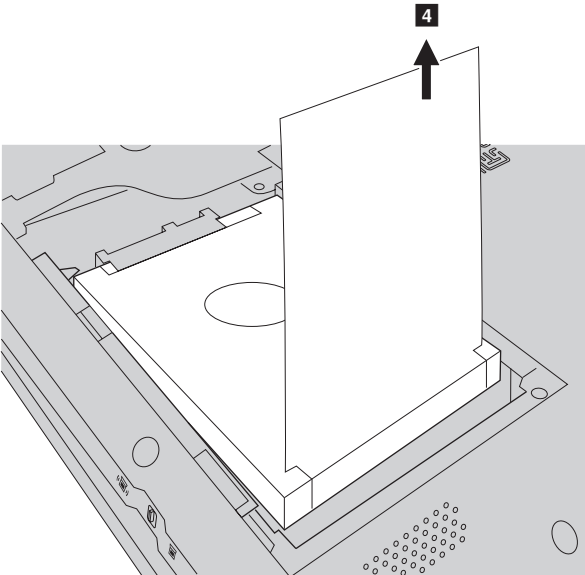

- 7 Take out the hard disk drive secured in a metal frame **5**.

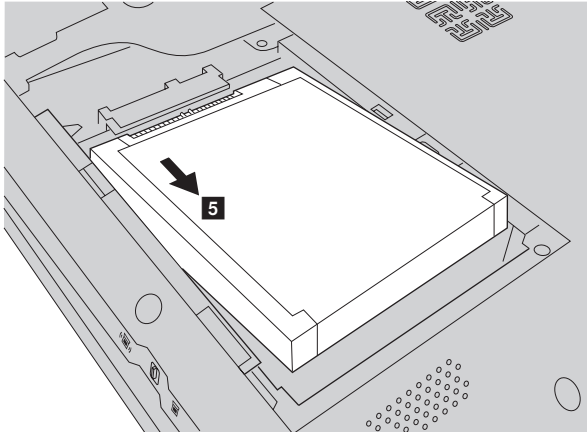

- 8 Remove the screws and detach the metal frame from the hard disk drive.
- 9 Attach the metal frame to a new hard disk drive and tighten the screws.
- 10 Put the hard disk drive gently into the hard disk drive bay with the tab facing upwards and the connectors facing each other; then push it firmly into space.
- 11 Reinstall the frame fixing screw.
- 12 Reinstall the compartment cover and tighten the screws.
- 13 Reinstall the battery pack.
- 14 Turn the computer over again. Connect the AC adapter and the cables to the computer again.

### ■ ■ Replacing memory

You can increase the amount of memory in your computer by installing a double-data-rate three synchronous dynamic random access memory (DDR3 SDRAM)-available as an option-in the memory slot of your computer. DDR3 SDRAMs are available in various capacities.

**Note:** Use only the memory types supported by your computer. If you incorrectly install optional memory, or install an unsupported memory type, a warning beep will sound when you try to start the computer.

To install a DDR3 SDRAM, do the following:

- ❶ Touch a metal table or a grounded metal object to reduce any static electricity in your body, which could damage the DDR3 SDRAM. Do not touch the contact edge of the DDR3 SDRAM.
- ❷ Turn off the computer. Disconnect the AC adapter and all cables from the computer.
- ❸ Close the computer display, and turn the computer over.
- ❹ Remove the battery pack.
- ❺ Remove the Hard disk drive (HDD)/Memory/Mini PCI Express Card slot compartment cover.
  - a. Loosen the screws that secure the compartment cover ❶ .
  - b. Remove the compartment cover ❷ .

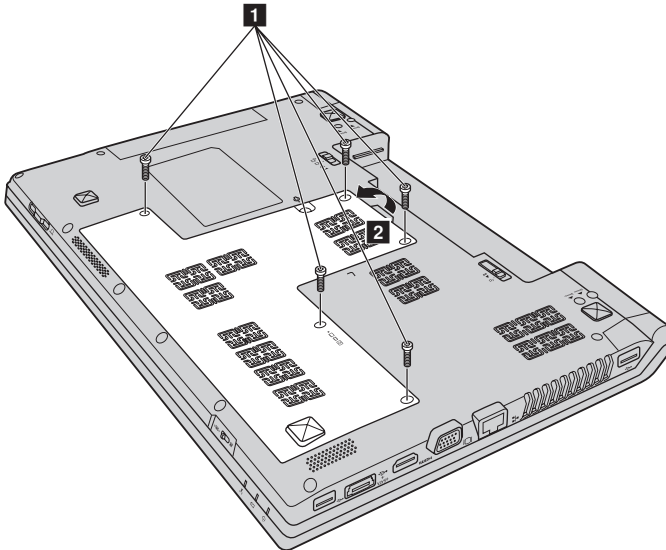



- 6 If two DDR3 SDRAMs are already installed in the memory slot, remove one of them to make room for the new one by pressing out on the latches on both edges of the socket at the same time. Be sure to save the old DDR3 SDRAM for future use.

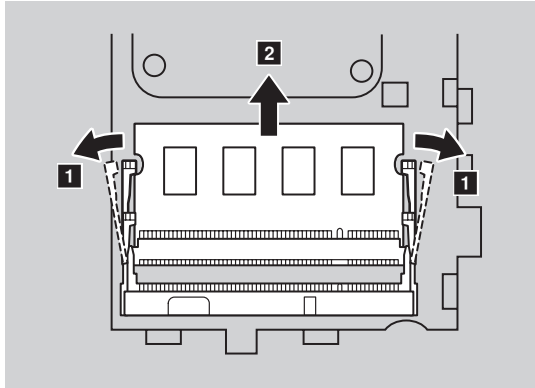

- 7 Align the notch of the DDR3 SDRAM with the protrusion of the socket and gently insert the DDR3 SDRAM into the socket at a 30-45° angle.
- 8 Push the DDR3 SDRAM inward toward the socket until the latches on both edges of the socket are pushed into the closed position.

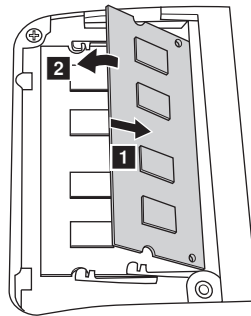

- 9 Reinstall the compartment cover and tighten the screws.
- 10 Reinstall the battery pack.
- 11 Turn the computer over again. Connect the AC adapter and the cables to the computer again.

## Appendix A. CRU instructions

**Note:** If only one DDR3 SDRAM is used on the computer you are servicing, the card must be installed in SLOT-0 (**a**: lower slot), but not in SLOT-1 (**b**: upper slot).

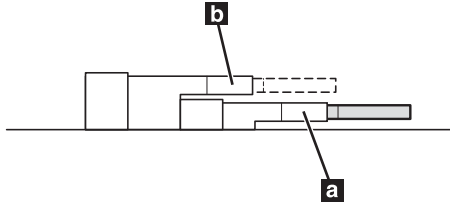

To make sure that the DDR3 SDRAM is installed correctly, do as follows:

- 1 Turn the computer on.
- 2 Hold **F2** during startup. The BIOS setup utility screen opens. The **System Memory** item shows the total amount of memory installed in your computer.

## ■ ■ Removing the optical drive

To remove the optical drive, do the following:

- 1 Remove the screw shown in the illustration 1.
- 2 Gently pull the optical drive out 2.

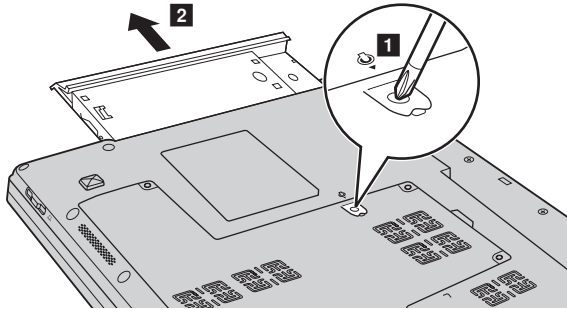

The following table provides a list of CRUs (Customer Replaceable Units) for your computer, and informs you of where to find replacement instructions.

	Setup Poster	User Guide
AC adapter	O	
Power cord for AC adapter	O	
Battery	O	O
Bottom access doors		O
Hard disk drive		O
Memory		O
Optical drive		O

## Appendix B. Lenovo limited warranty

L505-0010-01 04/2008

This Lenovo Limited Warranty applies only to Lenovo branded hardware products you purchased for your own use and not for resale.

This Lenovo Limited Warranty is available in other languages at [www.lenovo.com/warranty](http://www.lenovo.com/warranty).

### ■ What this warranty covers

Lenovo warrants that each hardware product that you purchase is free from defects in materials and workmanship under normal use during the warranty period. The warranty period for the product starts on the original date of purchase specified on your sales receipt or invoice unless Lenovo informs you otherwise in writing. The warranty period and type of warranty service that apply to your product are designated below under the section titled “**Warranty information**”.

**THIS WARRANTY IS YOUR EXCLUSIVE WARRANTY AND REPLACES ALL OTHER WARRANTIES OR CONDITIONS, EXPRESS OR IMPLIED, INCLUDING, BUT NOT LIMITED TO, THE IMPLIED WARRANTIES OR CONDITIONS OF MERCHANTABILITY AND FITNESS FOR A PARTICULAR PURPOSE. SOME STATES OR JURISDICTIONS DO NOT ALLOW THE EXCLUSION OF EXPRESS OR IMPLIED WARRANTIES, SO THE ABOVE EXCLUSION MAY NOT APPLY TO YOU. IN THAT EVENT, SUCH WARRANTIES APPLY ONLY TO THE EXTENT REQUIRED BY LAW AND ARE LIMITED IN DURATION TO THE WARRANTY PERIOD. NO WARRANTIES APPLY AFTER THAT PERIOD. SOME STATES OR JURISDICTIONS DO NOT ALLOW LIMITATIONS ON HOW LONG AN IMPLIED WARRANTY LASTS, SO THE ABOVE LIMITATION ON DURATION MAY NOT APPLY TO YOU.**

### ■ How to obtain warranty service

If the product does not function as warranted during the warranty period, you may obtain warranty service by contacting Lenovo or an approved service provider. Each of them is referred to as a “Service Provider.” A list of Service Providers and their telephone numbers is available at [www.lenovo.com/support/phone](http://www.lenovo.com/support/phone).

Warranty service may not be available in all locations and may differ from location to location. Charges may apply outside a Service Provider’s normal service area. Contact a local Service Provider for location-specific information.

### ■ What your service provider will do to correct problems

When you contact a Service Provider, you must follow the problem determination and resolution procedures specified.

Your Service Provider will attempt to diagnose and resolve your problem over the telephone, e-mail or through remote assistance. Your Service Provider may direct you to download and install designated software updates.

Some problems can be resolved with a replacement part that you can install yourself called a “Customer Replaceable Unit” or “CRU.” If so, your Service Provider will ship the CRU to you to install.

If your problem cannot be resolved over the telephone or remotely, through your application of software updates or the installation of a CRU by you, your Service Provider will arrange for service under the type of warranty service designated for the product under the section titled “**Warranty information**”.

If your Service Provider determines that it is unable to repair your product, your Service Provider will replace it with one that is at least functionally equivalent.

If your Service Provider determines that it is unable to either repair or replace your product, your sole remedy is to return the product to your place of purchase or to Lenovo for a refund of your purchase price.

### ■ Replacement of a product or part

When the warranty service involves the replacement of a product or part, the replaced product or part becomes Lenovo’s property and the replacement product or part becomes your property. Only unaltered Lenovo products and parts are eligible for replacement. The replacement product or part provided by Lenovo may not be new, but it will be in good working order and at least functionally equivalent to the original product or part. The replacement product or part shall be warranted for the balance of the period remaining on the original product.

Before your Service Provider replaces a product or part, you agree to:

- ① remove all features, parts, options, alterations, and attachments not under warranty service;
- ② ensure that the product or part is free of any legal obligations or restrictions that prevent its replacement; and
- ③ obtain authorization from the owner to have your Service Provider service a product or part if you do not own it.

### ■ Your additional responsibilities

Where applicable, before service is provided, you agree to:

- ① follow the service request procedures that your Service Provider specifies;
- ② backup or secure all programs and data contained in the product;
- ③ provide your Service Provider with all system keys or passwords and sufficient, free, and safe access to your facilities to perform service; and
- ④ ensure that all information about identified or identifiable individuals (“Personal Data”) is deleted from the product or that, with respect to any Personal Data that you did not delete, you are in compliance with all applicable laws.

## Appendix B. Lenovo limited warranty

### ■ Use of personal information

If you obtain service under this warranty, Lenovo will store, use and process information about your warranty service and your contact information, including name, phone numbers, address, and e-mail address. Lenovo will use this information to perform service under this warranty and to improve our business relationship with you. We may contact you to inquire about your satisfaction regarding our warranty service or to notify you about any product recalls or safety issues. In accomplishing these purposes, we may transfer your information to any country where we do business and may provide it to entities acting on our behalf. We may also disclose it where required by law.

### ■ What this warranty does not cover

This warranty does not cover the following:

- uninterrupted or error-free operation of a product;
- loss of, or damage to, your data;
- any software programs, whether provided with the product or installed subsequently;
- failure or damage resulting from misuse, accident, modification, unsuitable physical or operating environment, natural disasters, power surges, or improper maintenance by you;
- damage caused by a non-authorized service provider;
- failure of, or damage caused by, any third party products, including those that Lenovo may provide or integrate into the Lenovo product at your request; and
- any technical or other support, such as assistance with “how-to” questions and those regarding product set-up and installation.

This warranty is voided by removal or alteration of identification labels on the product or its parts.

### ■ Limitation of liability

Lenovo is responsible for loss or damage to your product only while it is: 1) in your Service Provider’s possession; or 2) in transit in those cases where the Service Provider is responsible for the transportation.

Neither Lenovo nor your Service Provider is responsible for any of your data including confidential, proprietary, or personal data contained in a product. You should remove and/or backup all such information from the product prior to its service or return.

Circumstances may arise where, because of a default on Lenovo’s part or other liability, you may be entitled to recover damages from Lenovo. In each such instance, regardless of the basis of your claim against Lenovo (including breach, negligence, misrepresentation, or other contract or tort claim), except and to the extent that liability cannot be waived or limited by applicable laws, Lenovo shall not be liable for more than the amount of actual direct damages suffered by you, up to the amount you paid for the product. This limit does not apply to damages for bodily injury (including death) and damage to real property or tangible personal property for which Lenovo is liable under law.

This limit also applies to Lenovo's suppliers, resellers, and your Service Provider. It is the maximum amount for which Lenovo, its suppliers, resellers, and your Service Provider are collectively responsible.

**UNDER NO CIRCUMSTANCES SHALL LENOVO, ITS SUPPLIERS, RESELLERS, OR SERVICE PROVIDERS BE LIABLE FOR ANY OF THE FOLLOWING EVEN IF INFORMED OF THEIR POSSIBILITY: 1) THIRD PARTY CLAIMS AGAINST YOU FOR DAMAGES; 2) LOSS OR DAMAGE TO YOUR DATA; OR 3) SPECIAL, INCIDENTAL, INDIRECT OR CONSEQUENTIAL DAMAGES, INCLUDING LOST PROFITS, BUSINESS REVENUE, GOODWILL OR ANTICIPATED SAVINGS. AS SOME STATES OR JURISDICTIONS DO NOT ALLOW THE EXCLUSION OR LIMITATION OF INCIDENTAL OR CONSEQUENTIAL DAMAGES, THE ABOVE LIMITATION OR EXCLUSION MAY NOT APPLY TO YOU.**

### ■ **Dispute resolution**

If you acquired the product in **Cambodia, Indonesia, Philippines, Vietnam or Sri Lanka**, disputes arising out of or in connection with this warranty shall be finally settled by arbitration held in Singapore and this warranty shall be governed, construed and enforced in accordance with the laws of Singapore, without regard to conflict of laws. If you acquired the product in **India**, disputes arising out of or in connection with this warranty shall be finally settled by arbitration held in Bangalore, India. Arbitration in Singapore shall be held in accordance with the Arbitration Rules of Singapore International Arbitration Center ("SIAC Rules") then in effect. Arbitration in India shall be held in accordance with the laws of India then in effect. The arbitration award shall be final and binding on the parties without appeal. Any award shall be in writing and set forth the findings of fact and the conclusions of law. All arbitration proceedings, including all documents presented in such proceedings, shall be conducted in the English language, and the English language version of this warranty prevails over any other language version in such proceedings.

### ■ **Other rights**

**THIS WARRANTY GIVES YOU SPECIFIC LEGAL RIGHTS AND YOU MAY HAVE OTHER RIGHTS WHICH VARY FROM STATE TO STATE OR JURISDICTION TO JURISDICTION. YOU MAY ALSO HAVE OTHER RIGHTS UNDER APPLICABLE LAW OR WRITTEN AGREEMENT WITH LENOVO. NOTHING IN THIS WARRANTY AFFECTS STATUTORY RIGHTS, INCLUDING RIGHTS OF CONSUMERS UNDER NATIONAL LEGISLATION GOVERNING THE SALE OF CONSUMER GOODS THAT CANNOT BE WAIVED OR LIMITED BY CONTRACT.**

### ■ **European Economic Area (EEA)**

Customers in the EEA may contact Lenovo at the following address: EMEA Service Organisation, Lenovo (International) B.V., Floor 2, Einsteinova 21, 851 01, Bratislava, Slovakia. Service under this warranty for Lenovo hardware products purchased in EEA countries may be obtained in any EEA country in which the product has been announced and made available by Lenovo.

## Appendix B. Lenovo limited warranty

### ■ ■ Warranty information

Product or machine type	Country or region of purchase	Warranty period	Type of warranty service	
notebook: 20068, 4330	Taiwan, Korea	parts and labor - 1 year battery pack - 1 year	3, 4	
	Singapore		1, 3, 4	
	China (Hong Kong S.A.R.), China (Macau S.A.R.), India, Indonesia, Malaysia, Thailand, Philippines, Vietnam, Bahrain, Kuwait, Oman, Qatar, Egypt, South Africa, Saudi Arabia, UAE, Algeria, Nigeria, Kenya		1, 4	
	Bosnia-Herzegovina, Bulgaria, Croatia, Czech Republic, Cyprus, Estonia, Greece, Hungary, Latvia, Lithuania, Macedonia, Poland, Romania, Slovakia, Slovenia, Serbia		1, 3	
	Australia, New Zealand, Japan, Austria, Belgium, Denmark, France, Finland, Germany, Iceland, Israel, Ireland, Italy, Luxembourg, Netherlands, Norway, Spain, Sweden, Switzerland, the United Kingdom			
	United States of America, Canada, Mexico, Brazil, Argentina, Colombia, Peru, Venezuela, Bolivia, Uruguay, Chile, Paraguay, Ecuador		parts and labor - 1 year limited warranty* battery pack - 1 year	1, 4
	Russia, Ukraine, the Republic of Kazakhstan, Belarus, Sri Lanka, Turkmenistan		parts and labor - 1 year battery pack - 1 year	4
	Turkey		parts and labor - 2 years battery pack - 1 year	1, 4
* Excludes some components. 90-day limited warranty for power adapters, keyboards, plastics and hinges.				

If required, your Service Provider will provide repair or exchange service depending on the type of warranty service specified for your product and the available service. Scheduling of service will depend upon the time of your call, parts availability, and other factors.



■ **Types of warranty service**

① **Customer Replaceable Unit (“CRU”) Service**

Under CRU Service, your Service Provider will ship CRUs to you for installation by you. CRU information and replacement instructions are shipped with your product and are available from Lenovo at any time upon request. CRUs that are easily installed by you are called Self-service CRUs, while Optional-service CRUs may require some technical skill and tools. Installation of Self-service CRUs is your responsibility. You may request that a Service Provider install Optional-service CRUs under one of the other types of warranty service designated for your product. An optional service offering may be available for purchase from Lenovo to have Lenovo install Self-service CRUs for you. You may find a list of CRUs and their designation in the publication that ships with your product or at [www.lenovo.com/CRUs](http://www.lenovo.com/CRUs). The requirement to return a defective CRU, if any, will be specified in the materials shipped with a replacement CRU. When return is required: 1) return instructions, a prepaid return shipping label, and a container will be included with the replacement CRU; and 2) you may be charged for the replacement CRU if your Service Provider does not receive the defective CRU within thirty (30) days of your receipt of the replacement.

② **On-site Service**

Under On-Site Service, your Service Provider will either repair or exchange the product at your location. You must provide a suitable working area to allow disassembly and reassembly of the Lenovo product. For some products, certain repairs may require your Service Provider to send the product to a designated service center.

③ **Courier or Depot Service**

Under Courier or Depot Service, your product will be repaired or exchanged at a designated service center, with shipping arranged by your Service Provider. You are responsible for disconnecting the product. A shipping container will be provided to you for you to return your product to a designated service center. A courier will pick up your product and deliver it to the designated service center. Following its repair or exchange, the service center will arrange the return delivery of the product to you.

④ **Customer Carry-In or Mail-In Service**

Under Customer Carry-In or Mail-In Service, your product will be repaired or exchanged at a designated service center, with delivery or shipping arranged by you. You are responsible to deliver or mail, as your Service Provider specifies, (prepaid by you unless specified otherwise) the product, suitably packaged to a designated location. After the product has been repaired or exchanged, it will be made available for your collection. Failure to collect the product may result in your Service Provider disposing of the product as it sees fit. For Mail-in Service, the product will be returned to you at Lenovo’s expense, unless your Service Provider specifies otherwise.

## Appendix B. Lenovo limited warranty

### 5 Product Exchange Service

Under Product Exchange Service, Lenovo will ship a replacement product to your location. You are responsible for its installation and verification of its operation. The replacement product becomes your property in exchange for the failed product, which becomes the property of Lenovo. You must pack the failed product in the shipping carton used to ship the replacement product and return it to Lenovo. Transportation charges, both ways, are paid by Lenovo. Failure to use the carton in which the replacement product was received may result in your responsibility for damage to the failed product during shipment. You may be charged for the replacement product if Lenovo does not receive the failed product within thirty (30) days of your receipt of the replacement product.

## Appendix C. Product specific Notices

The notices in this appendix are specific to the product with the given MT number. Notices that are common for most Lenovo products are included in “Appendix A. Notices” of the *Lenovo Safety and General Information Guide*.

### ■ ■ Energy star information

---



ENERGY STAR® is a joint program of the U.S. Environmental Protection Agency and the U.S. Department of Energy aimed at saving money and protecting the environment through energy efficient products and practices.

Lenovo® is proud to offer our customers products with an ENERGY STAR compliant designation. Lenovo computers of the following machine types, if the ENERGY STAR mark is affixed, have been designed and tested to conform to the ENERGY STAR 5.0 program requirements for computers.

- 20068, 4330

By using ENERGY STAR compliant products and taking advantage of the power-management features of your computer, you reduce the consumption of electricity. Reduced electrical consumption contributes to potential financial savings, a cleaner environment, and the reduction of greenhouse gas emissions.

For more information about ENERGY STAR, visit <http://www.energystar.gov>.

Lenovo encourages you to make efficient use of energy an integral part of your day-to-day operations. To help in this endeavor, Lenovo has preset the following power-management features to take effect when your computer has been inactive for a specified duration:

## Appendix C. Product specific Notices

Table 1. ENERGY STAR power-management features

### Windows® 7

Power plan: Energy Star

- Turn off the display:  
After 10 minutes
- Put the computer to sleep:  
After 25 minutes
- Advanced power settings:
  - Turn off hard disks:  
After 20 minutes
  - Hibernate: After 1 hour

To awaken your computer from a Sleep mode, press any key on your keyboard. For more information about these settings, refer to your Windows Help and Support information system.

## ■ ■ Electronic emissions notices

---

The following information refers to Lenovo B560, machine type 20068, 4330.

### ■ Federal Communications Commission (FCC) Statement

This equipment has been tested and found to comply with the limits for a Class B digital device, pursuant to Part 15 of the FCC Rules. These limits are designed to provide reasonable protection against harmful interference in a residential installation. This equipment generates, uses, and can radiate radio frequency energy and, if not installed and used in accordance with the instructions, may cause harmful interference to radio communications. However, there is no guarantee the interference will not occur in a particular installation. If this equipment does cause harmful interference to radio or television reception, which can be determined by turning the equipment off and on, the user is encouraged to try to correct the interference by one or more of the following measures:

- Reorient or relocate the receiving antenna.
- Increase the separation between the equipment and receiver.
- Connect the equipment into an outlet on a circuit different from that to which the receiver is connected.
- Consult an authorized dealer or service representative for help.

Properly shielded and grounded cables and connectors must be used in order to meet FCC emission limits. Proper cables and connectors are available from Lenovo authorized dealers. Lenovo is not responsible for any radio or television interference caused by using other than recommended cables or connectors or by unauthorized changes or modifications to this equipment. Unauthorized changes or modifications could void the user's authority to operate the equipment.

This device complies with Part 15 of the FCC Rules. Operation is subject to the following two conditions: (1) this device may not cause harmful interference, and (2) this device must accept any interference received, including interference that may cause undesired operation.

Responsible party:

Lenovo (United States) Incorporated

1009 Think Place - Building One

Morrisville, NC 27560

U.S.A.

Telephone: (919) 294-5900



## Appendix C. Product specific Notices

### ■ Industry Canada Class B Emission Compliance Statement

This Class B digital apparatus complies with Canadian ICES-003.

### ■ Avis de conformité à la réglementation d'Industrie Canada

Cet appareil numérique de la classe B est conforme à la norme NMB-003 du Canada.

### ■ German Class B Compliance Statement

Deutschsprachiger EU Hinweis:

#### **Hinweis für Geräte der Klasse B EU-Richtlinie zur Elektromagnetischen Verträglichkeit**

Dieses Produkt entspricht den Schutzanforderungen der EU-Richtlinie 2004/108/EG (früher 89/336/EWG) zur Angleichung der Rechtsvorschriften über die elektromagnetische Verträglichkeit in den EU-Mitgliedsstaaten und hält die Grenzwerte der EN 55022 Klasse B ein.

Um dieses sicherzustellen, sind die Geräte wie in den Handbüchern beschrieben zu installieren und zu betreiben. Des Weiteren dürfen auch nur von der Lenovo empfohlene Kabel angeschlossen werden. Lenovo übernimmt keine Verantwortung für die Einhaltung der Schutzanforderungen, wenn das Produkt ohne Zustimmung der Lenovo verändert bzw. wenn Erweiterungskomponenten von Fremdherstellern ohne Empfehlung der Lenovo gesteckt/eingebaut werden.

#### **Deutschland:**

#### **Einhaltung des Gesetzes über die elektromagnetische Verträglichkeit von Betriebsmitteln**

Dieses Produkt entspricht dem "Gesetz über die elektromagnetische Verträglichkeit von Betriebsmitteln" EMVG (früher "Gesetz über die elektromagnetische Verträglichkeit von Geräten"). Dies ist die Umsetzung der EU-Richtlinie 2004/108/EG (früher 89/336/EWG) in der Bundesrepublik Deutschland.

#### **Zulassungsbescheinigung laut dem Deutschen Gesetz über die elektromagnetische Verträglichkeit von Betriebsmitteln, EMVG vom 20. Juli 2007 (früher Gesetz über die elektromagnetische Verträglichkeit von Geräten), bzw. der EMV EG Richtlinie 2004/108/EC (früher 89/336/EWG), für Geräte der Klasse B.**

Dieses Gerät ist berechtigt, in Übereinstimmung mit dem Deutschen EMVG das EG-Konformitätszeichen - CE - zu führen. Verantwortlich für die Konformitätserklärung nach Paragraf 5 des EMVG ist die Lenovo (Deutschland) GmbH, Gropiusplatz 10, D-70563 Stuttgart.

Informationen in Hinsicht EMVG Paragraf 4 Abs. (1) 4:

**Das Gerät erfüllt die Schutzanforderungen nach EN 55024 und EN 55022 Klasse B.**

■ **European Union Compliance Statement Class B Compliance**

European Union - Compliance to the Electromagnetic Compatibility Directive



This product is in conformity with the protection requirements of EU Council Directive 2004/108/EC on the approximation of the laws of the Member States relating to electromagnetic compatibility. Lenovo cannot accept responsibility for any failure to satisfy the protection requirements resulting from a non-recommended modification of the product, including the installation of option cards from other manufacturers.

This product has been tested and found to comply with the limits for Class B Information Technology Equipment according to European Standard EN 55022. The limits for Class B equipment were derived for typical residential environments to provide reasonable protection against interference with licensed communication devices.

Properly shielded and grounded cables and connectors must be used in order to reduce the potential for causing interference to radio and TV communications and to other electrical or electronic equipment. Such cables and connectors are available from Lenovo authorized dealers. Lenovo cannot accept responsibility for any interference caused by using other than recommended cables and connectors.

# Appendix D. Specifications

**Model Name: B560**

**Machine Type 20068 / 4330**

**Note:** The following specifications may contain technical inaccuracies or typographical errors. Lenovo reserves the right to improve and/or change specifications at any time without notice.

## Form Factor

Size	Appr. 378 mm × 252 mm × 20~34 mm
Weight	Appr. 2.5 kg with 6 cell battery

## System

CPU	Intel Calpella processor
Memory	DDR3, 2 × SODIMM slot
LCD	15.6-inch HD LCD
HDD	2.5-inch, 9.5mm SATA
Keyboard	6-row Lenovo Keyboard
Integrated Camera	0.3 mega pixel camera
Battery	48 Wh, 6 cells Li-ion battery
AC Adapter	20 V, 65 W

## I/O Ports

USB	USB 2.0 port × 3, eSATA/USB port × 1
Communication	10/100 Mb or 10/100/1000 Mb
Audio	Headphone jack, Mic-in jack
Video	D-sub port, HDMI port
Memory card slot	4 in 1 slot × 1 (SD/MMC/MS/SD PRO)

## Others

Kensington slot	Yes
-----------------	-----



## Trademarks

The following terms are trademarks or registered trademarks of Lenovo in the United States, other countries, or both.

Lenovo  
OneKey

Microsoft and Windows are trademarks of Microsoft Corporation in the United States, other countries, or both.

Other company, products, or service names may be trademarks or service marks of others.

# Index

## A

AC adapter	
Using.....	10

## B

Battery	
Charging .....	10
Bluetooth	
Connecting.....	15

## C

Camera.....	2
-------------	---

## F

Fingerprint reader.....	18
Frequently Asked Questions.....	25
Function key combinations.....	12

## K

Keyboard	
Using.....	12

## L

Lenovo Limited Warranty .....	40
-------------------------------	----

## M

Memory card reader.....	14
Microphone	
Built-in.....	2

## N

Notice	
Electronic emissions .....	49

## O

OneKey Rescue system button.....	24
----------------------------------	----

## P

Password	
Problems.....	27
Using.....	18
Problems	
Battery.....	29
Computer screen.....	28
Display.....	27
Hard disk drive .....	29
Hibernation model.....	28
Password.....	27
Sleep model.....	28
Sound.....	28
Startup .....	29

## S

Security.....	18
SIM card .....	22

## T

Touchpad .....	11
Trademarks.....	53
Troubleshooting.....	27

## U

USB port.....	3, 14
---------------	-------

## W

Warranty information.....	44
---------------------------	----

***lenovo***<sup>®</sup>



**If your product is not working correctly,  
DO NOT RETURN IT TO THE STORE.**

For technical assistance, contact a Lenovo support specialist 24 hours a day by calling toll free **1-877-4 LENOVO (1-877-453-6686)**.

Additionally, you can find support information and updates on the Lenovo Web site located at **<http://consumersupport.lenovo.com>**.

\* Only for the users from the United States.

**lenovo**<sup>®</sup>

New World. New Thinking.<sup>™</sup>

[www.lenovo.com](http://www.lenovo.com)

©Lenovo China 2010



P/N: 147003455  
Printed in China